

LED Street Light



Product Spec:

Product Code	Dimension L*W*H [mm]	Power [W]	Input Voltage [V]	Efficiency [lm/W]	Color Temp[K]	CRI	Beam Angle	LED Chip
AL-ST1901-50W	588*350*118mm	50W	AC100-277V	130lm/W	3000K-6500K	≥80	60°90°120°	SMD3030
AL-ST1901-100W	688*350*118mm	100W	AC100-277V	130lm/W	3000K-6500K	≥80	60°90°120°	SMD3030
AL-ST1901-150W	688*350*118mm	150W	AC100-277V	130m/W	3000K-6500K	≥80	60°90°120°	SMD3030
AL-ST1901-200W	788*350*118mm	200W	AC100-277V	130m/W	3000K-6500K	≥80	60°90°120°	SMD3030
AL-ST1901-300W	788*350*118mm	300W	AC100-277V	130m/W	3000K-6500K	≥80	60°90°120°	SMD3030

Dimension(mm):

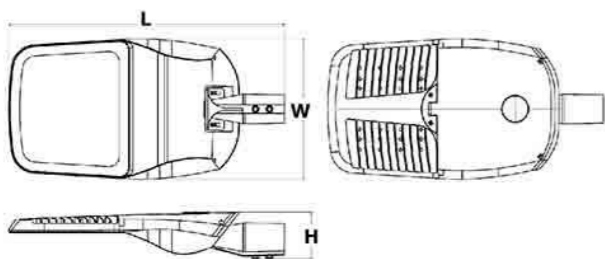

LED Street Light

Technical Parameters:

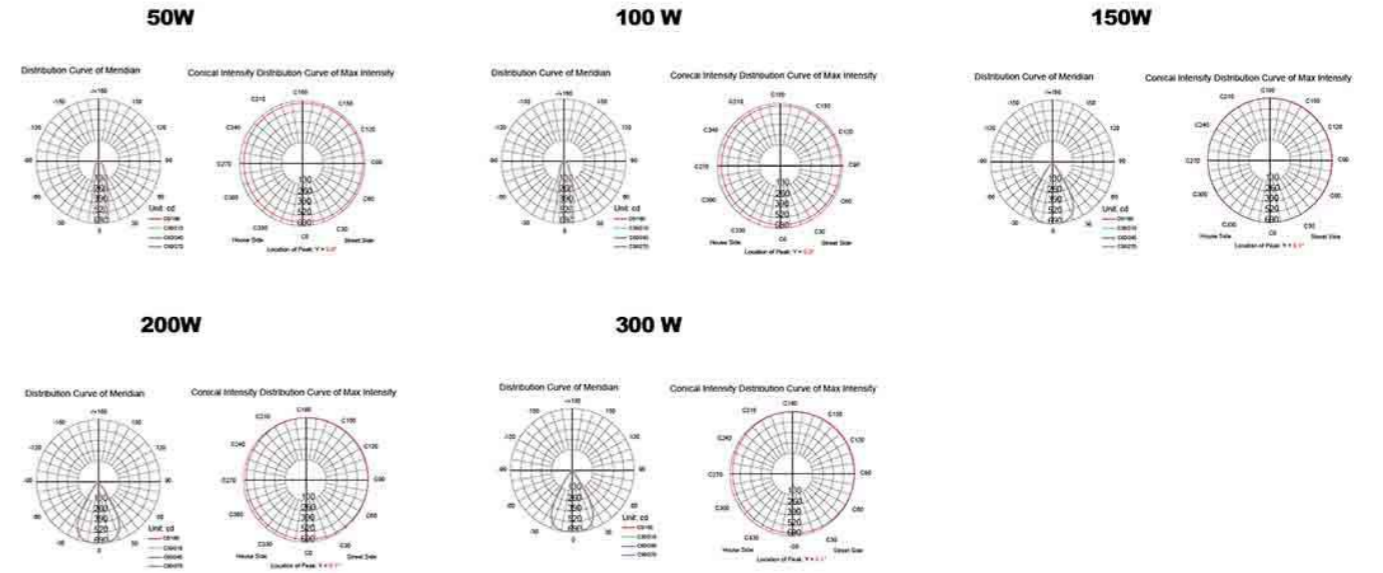

Beam Angle Graph:

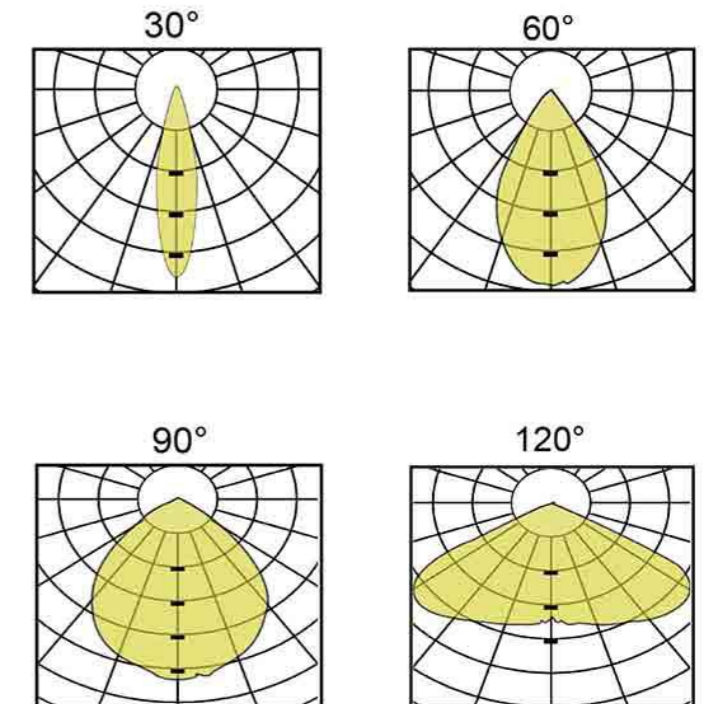

ALTEMPO Work Light Series



Product Spec:

Product Code	N.W.	Dimension L*W*H [mm]	Power [W]	Battery	Efficiency [lm/W]	Color Temp[K]	CRI	Material	Working time	Charging time
AL-TEMPFL2x10WB2F	440g	135*200*60 mm	2*10W	4*AA(excluded)	700-1000lm	3000K-6000K	≥80	Nylon+TPR	5hrs	Non
AL-TEMPFL2*10WUSB2F	575g	135*200*60 mm	2*10W	5000mAh lithium	700-1000lm	3000K-6000K	≥80	Nylon+TPR	5-9hrs	5hrs

Functions :

2 lights On - Top light On - bottom light On - Off

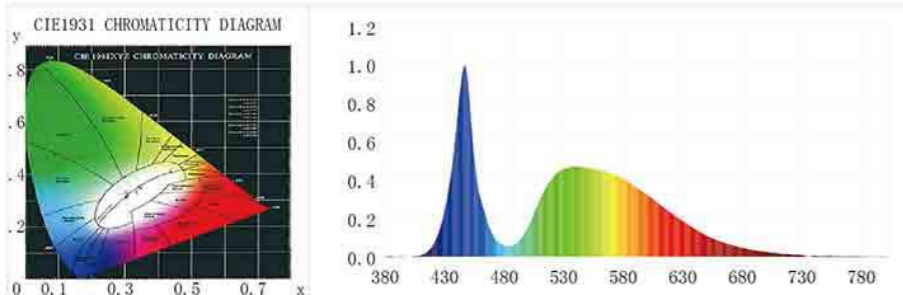

ALTEMPO Work Light Series



Product Spec:

Product Code	N.W.	Dimension L*W*H [mm]	Power [W]	Battery	Efficiency [lm/W]	Color Temp[K]	CRI	Material	Working time	Charging time
AL-TEMPFL10WB2	361g	172*127*46 mm	10W	4*AA(excluded)	500-750lm	3000K-6000K	≥80	Nylon+TPR	4hrs	Non
AL-TEMPFL10WUSB2	471g	172*127*46 mm	10W	2*2200mAh lithium	500-750lm	3000K-6000K	≥80	Nylon+TPR	5-6hrs	5hrs

Functions :

On-Off

Packing Details :

Product Code : AL-TEMPFL10WB2

Outer CTN Size: 54*22*28cm

24pcs/ctn

N.W.:361g/pcs

G.W.:12.76kg/ctn

Packing Details :

Product Code : AL-TEMPFL10WUSB2

Outer CTN Size: 40*31*32cm

20pcs/ctn

N.W.:471g/pcs

G.W.:10.20kg/ctn



ALTEMPO Work Light with Dimming Series



Product Spec:

Product Code	N.W.	Dimension L*W*H [mm]	Power [W]	Battery	Efficiency [lm/W]	Color Temp[K]	CRI	Material	Working time	Charging time
AL-TEMPFL10WB4	360g	172*127*46mm	10W	4*AA(excluded)	500-750lm	3000K-6000K	≥80	Nylon+TPR	4-5hrs	Non
AL-TEMPFL10WUSB4	471g	172*127*46mm	10W	4400mAh lithium	500-750lm	3000K-6000K	≥80	Nylon+TPR	4hrs	5hrs

Functions :

On-Dim-Flash-Off

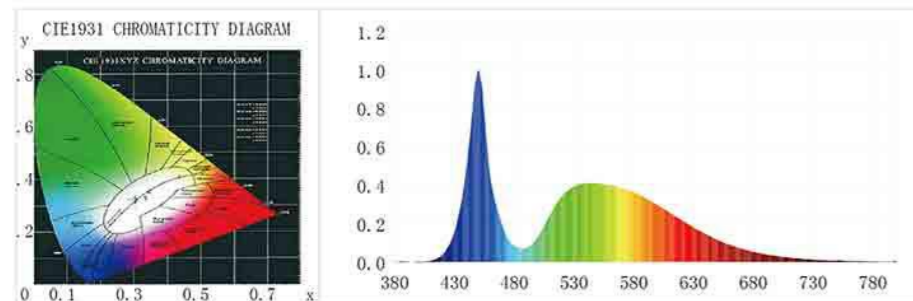

ALTEMPO Work Light ON/OFF Series



Product Spec:

Product Code	N.W.	Dimension L*W*H [mm]	Power [W]	Battery	Efficiency [lm/W]	Color Temp[K]	CRI	Material	Working time	Charging time
AL-TEMPFL2x10WB3S	360g	172*127*46 mm	2*10W	4*AA(excluded)	600-1150lm	3000K-6000K	≥80	Nylon+TPR	3-4hrs	Non
AL-TEMPFL2x10WUSB3S	471g	172*127*46 mm	2*10W	2*2200mAh lithium	600-1150lm	3000K-6000K	≥80	Nylon+TPR	4-5hrs	5hrs

Functions :

On-Off- Tunable On-Off

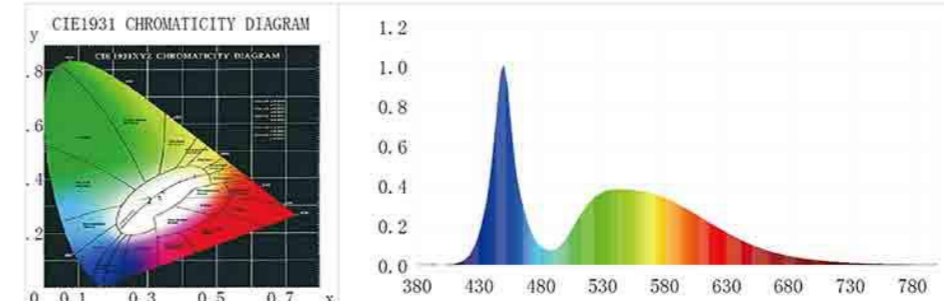

ALTEMPO Work Light with Long and Short Beam Series



Product Spec:

Product Code	N.W.	Dimension L*W*H [mm]	Power [W]	Battery	Efficiency [lm/W]	Color Temp[K]	CRI	Material	Working time	Charging time
AL-TEMPFL5/10WB2	360g	172*127*46mm	10+5W	4*AA(excluded)	800lm	3000K-6000K	≥80	Nylon+TPR	4-5hrs	Non
AL-TEMPFL5/10WUSB2	471g	172*127*46mm	10+5W	2*2200mAH lithium	800lm	3000K-6000K	≥80	Nylon+TPR	5-6hrs	5hrs

Functions :

On-Short Beam-Long Beam-Off

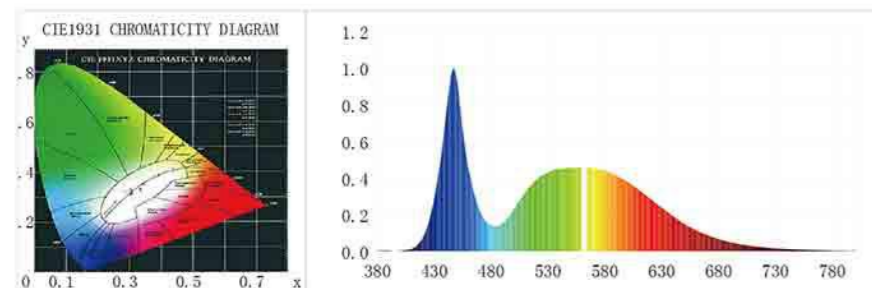

ALTEMPO Work Light with Speaker Series



Product Spec:

Product Code	N.W.	Dimension L*W*H [mm]	Power [W]	Battery	Efficiency [lm/W]	Color Temp[K]	CRI	Material	Working time	Charging time
AL-TEMPFL20WUSB4M	794g	230*170*58 mm	20W	8000mAH lithium	1100lm	3000K-6000K	≥80	Nylon+TPR	12hrs	5hrs

Functions :

On-Dim-Flash-Off
Speaker Volume
Bluetooth Linked

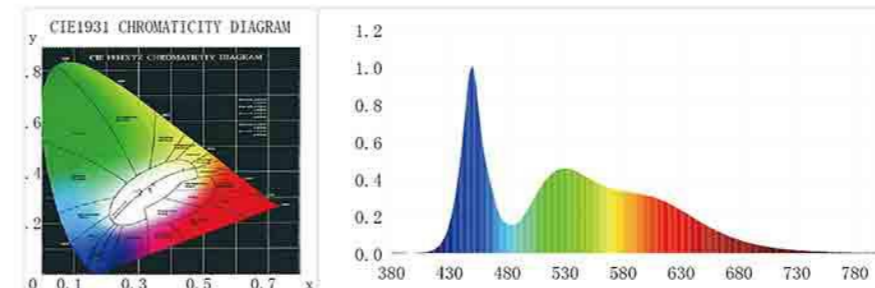

LED Illustro

Inground 3W

PATENTED



Product Spec:

Product Code	Dimension L*W[mm]	Power [W]	Input Voltage [V]	Efficiency [lm/W]	Color Temp[K]	CRI	Beam Angle	IP	LED Chip
AL-ILL80-1-3W	Φ78*118mm	3W	AC110V/AC220V/DC24V	90-95lm	3000K-6000K/R/G/B	≥80	90°	IP67	CREE3535
AL-ILL80-2-3W	Φ69*118mm	3W	AC110V/AC220V/DC24V	90-95lm	3000K-6000K/R/G/B	≥80	90°	IP67	CREE3535
AL-ILL80-5-3W	Φ70*104mm	3W	AC110V/AC220V/DC24V	90-95lm	3000K-6000K/R/G/B	≥80	25°/40°/60°	IP67	CREE3535

LED Illustro

Dimension(mm):

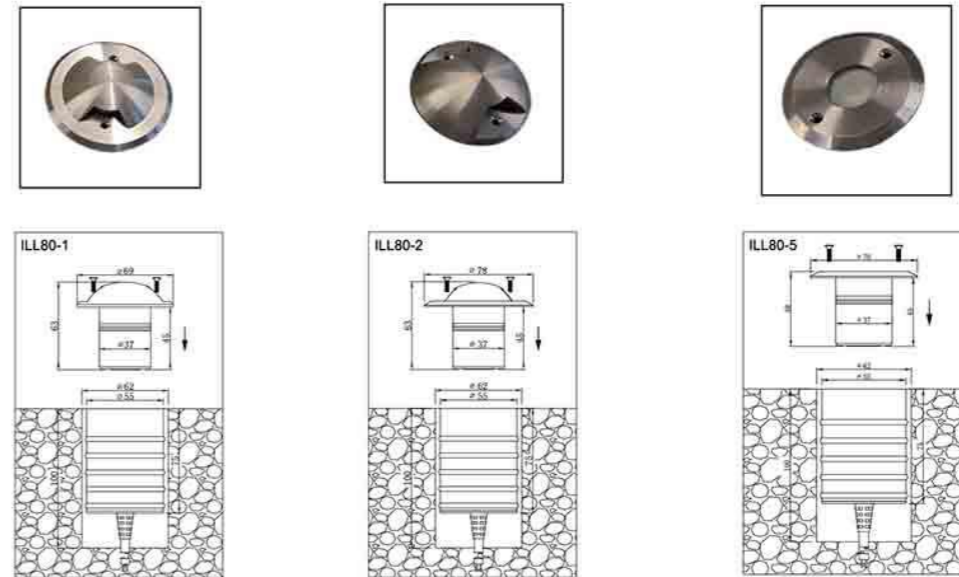

Beam Angle:

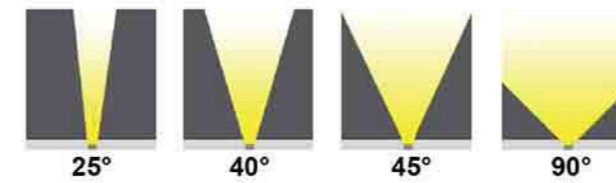

Display

AL-68CT

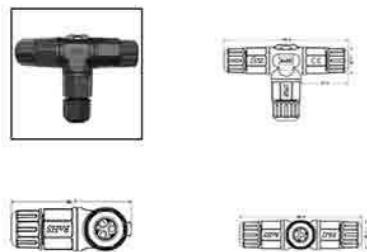

AL-68CS



LED Illustro

Inground 6W COB



AL-ILL125-COB-D-6W



AL-ILL125-COB-F-6W



Product Spec:

Product Code	Dimension L*W[mm]	Power [W]	Input Voltage [V]	Efficiency [lm/W]	Color Temp[K]	CRI	Beam Angle	IP	LED Chip
AL-ILL125-COB-D-6W	Φ127*155mm	6W	AC110V/AC220V/DC24V	420-450lm	3000K-6000K	≥80	40°	IP67	CREE 3535
AL-ILL125-COB-F-6W	Φ127*155mm	6W	AC110V/AC220V/DC24V	420-450lm	3000K-6000K	≥80	45°	IP67	CREE 3535

Details:



AL-68CT

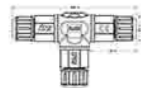

AL-68CS



LED Illustro

Dimension(mm):

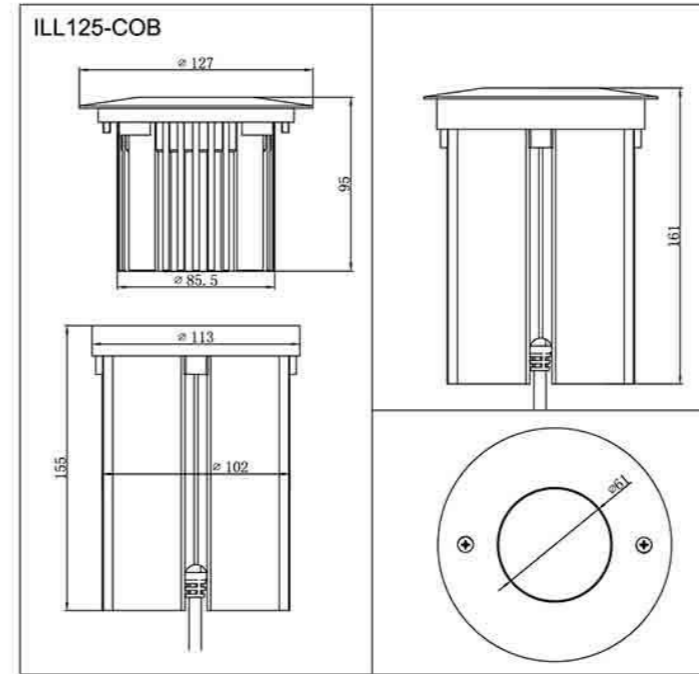

Beam Angle:

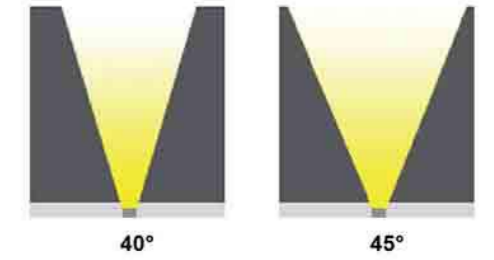

Luminous Intensity Distribution:

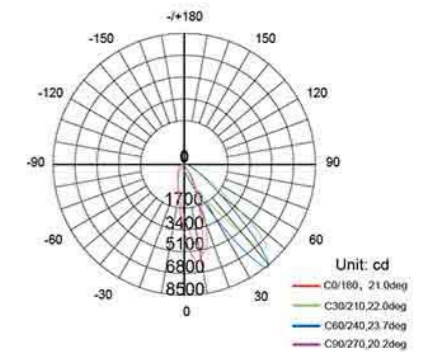

AVERAGE BEAM ANGLE(50%):21.0 DEG

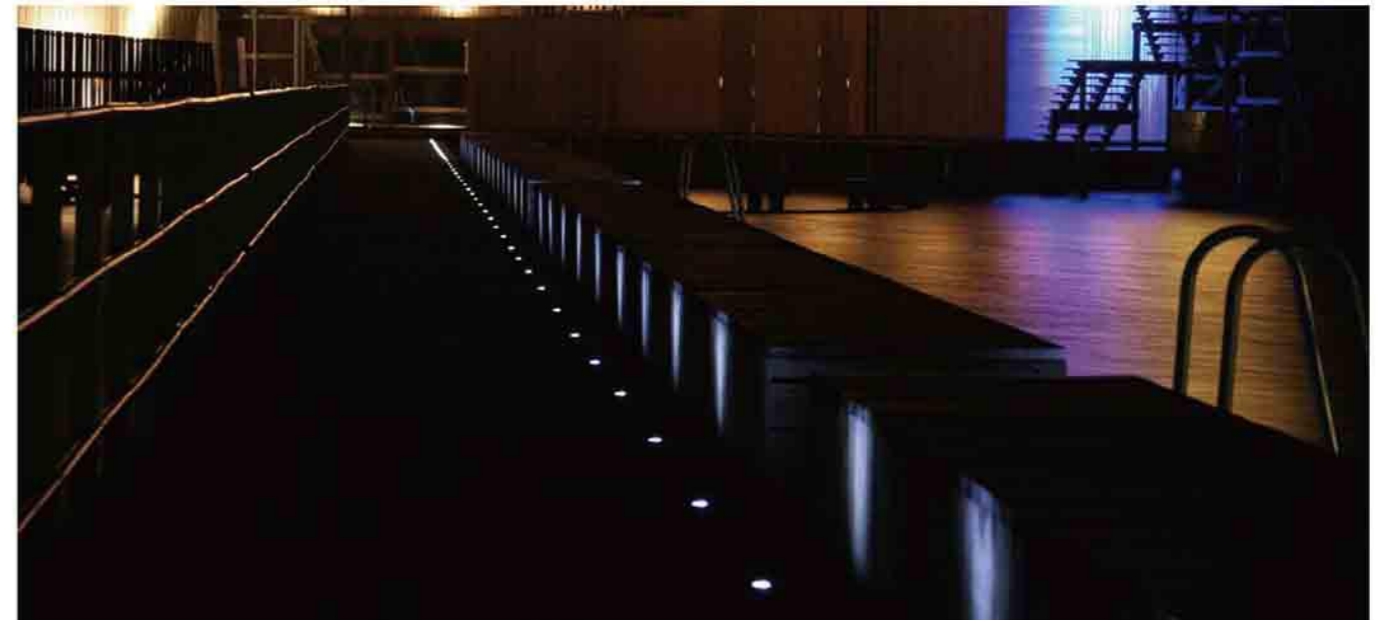

LED Illustro Inground 9W



PATENTED



Product Spec:

Product Code	Dimension L*W[mm]	Power [W]	Input Voltage [V]	Efficiency [lm/W]	Color Temp[K]	CRI	Beam Angle	IP	LED Chip
AL-ILL195-9W	Φ200*133mm	9W	AC110V/AC220V/DC24V	675-720lm	3000K-6000K	≥80	25°/40°/60°	IP67	CREE 3535

Details:



AL-68CT

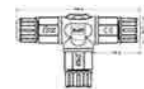

AL-68CS

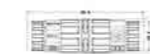

LED Illustro

Dimension(mm):

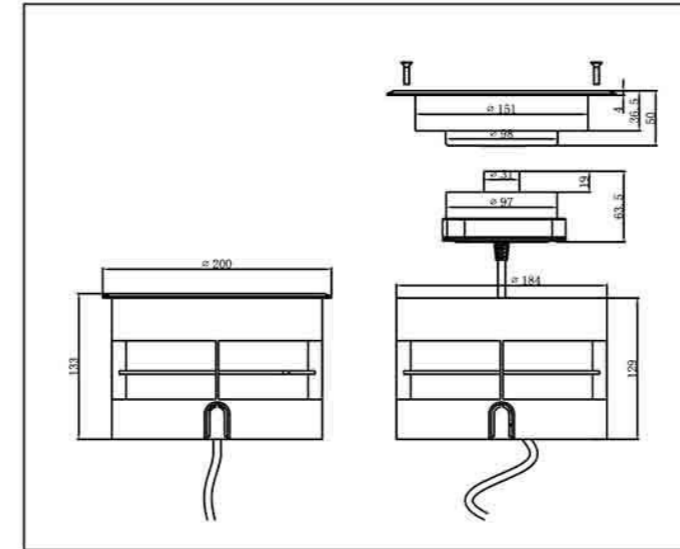

Beam Angle:

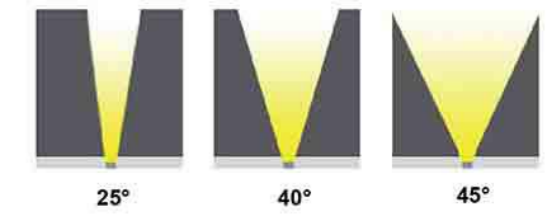

Luminous Intensity Distribution:

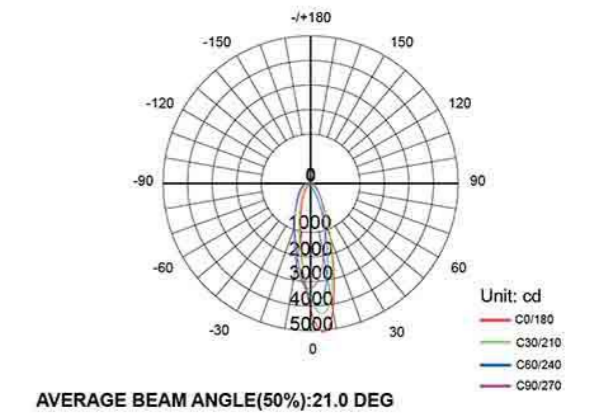

LED Illustro

Inground Tilt 18W



PATENTED



Product Spec:

Product Code	Dimension L*W[mm]	Power [W]	Input Voltage [V]	Efficiency [lm/W]	Color Temp[K]	CRI	Beam Angle	IP	LED Chip
AL-ILL230-18W	Φ227*133mm	18W	AC110V/AC220V/DC24V	1350-1450lm	3000K-6000K	≥80	25°/40°/60°	IP67	CREE 3535

Details:



AL-68CT

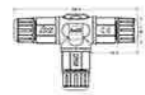

AL-68CS



LED Illustro

Dimension(mm):

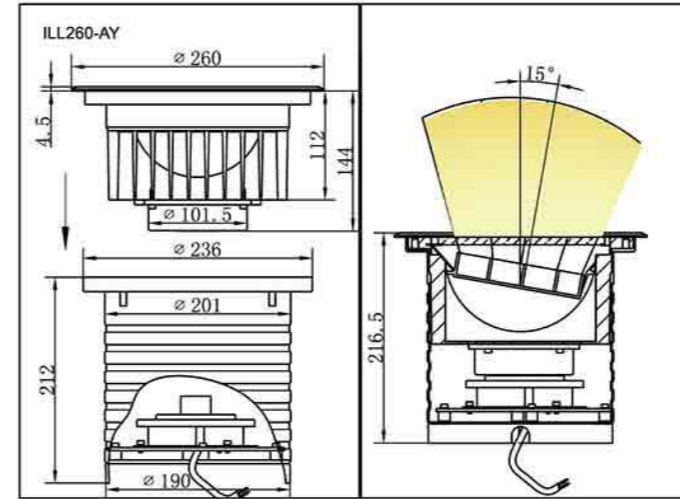

***316 BEZEL**

***2000KG LOAD BEARING**

Beam Angle:

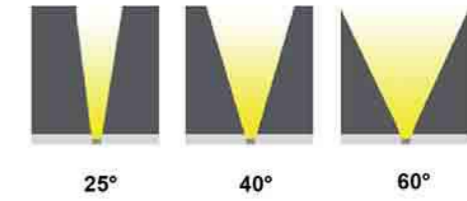

Luminous Intensity Distribution:

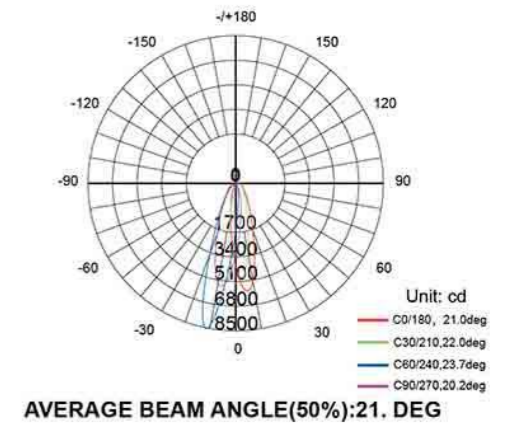

Belfast church

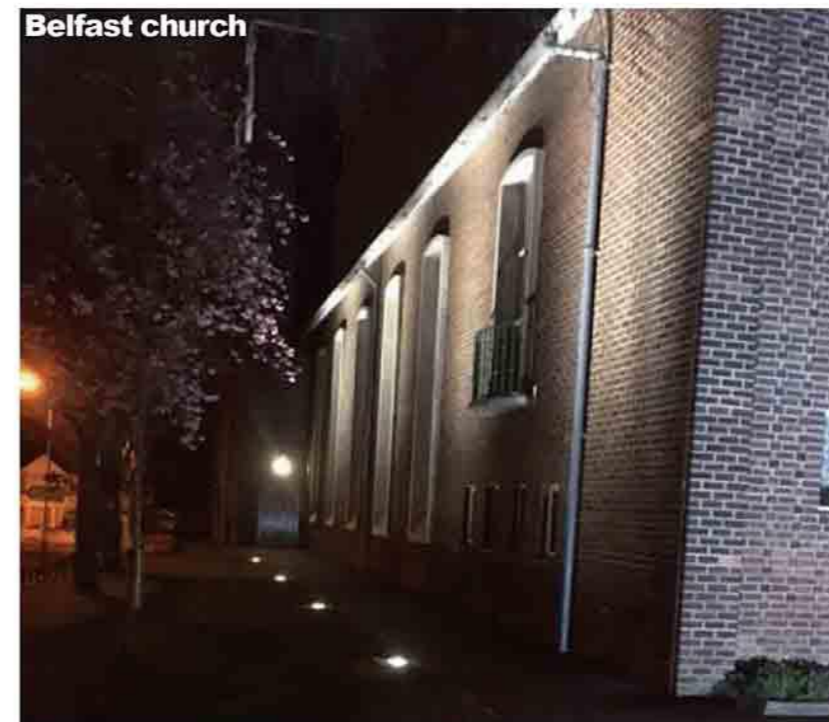

LED Illustro

Inground Linear



Product Spec:

Product Code	Dimension L*W[mm]	Power [W]	Input Voltage [V]	Efficiency [lm/W]	Color Temp[K]	CRI	Beam Angle	IP	LED Chip
AL-BD18-3-600-9W	Φ600*47.5*92mm	9W	AC110V/AC220V/DC24V	675-720lm	3000K-6000K	≥80	120°	IP67	SMD2835
AL-BD18-3-1000-12W	Φ1000*47.5*92mm	12W	AC110V/AC220V/DC24V	1350-1450lm	3000K-6000K	≥80	120°	IP67	SMD2835

Details:



PATENTED



AL-68CT

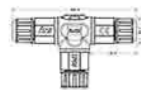

AL-68CS



LED Illustro

Dimension(mm):

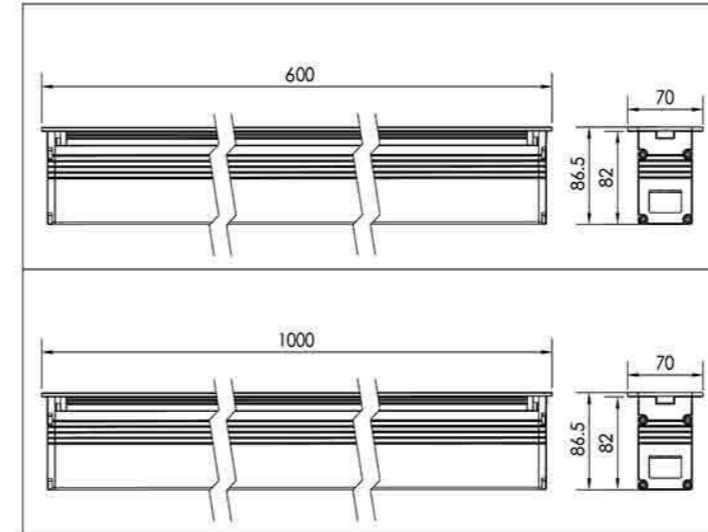

Beam Angle:

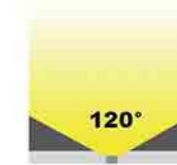

Luminous Intensity Distribution:

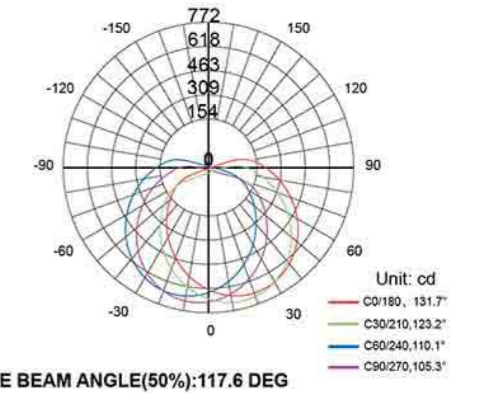

LED Illustro

SS Bollard



Details:



Product Spec:

Product Code	Dimension D*H[mm]	Power [W]	Input Voltage [V]	Efficiency [lm/W]	Color Temp[K]	CRI	IP	LED Chip
AL-Bolad-6W	Φ170/750/900mm	6W	AC220-240V	80LM/W	3000-6500K	≥80	IP66	CREE
AL-Bolad-9W	Φ170/750/900mm	9W	AC220-240V	80LM/W	3000-6500K	≥80	IP66	CREE
AL-Bolad-12W	Φ170/750/900mm	12W	AC220-240V	80LM/W	3000-6500K	≥80	IP66	CREE
AL-Bolad-18W	Φ170/750/900mm	18W	AC220-240V	80LM/W	3000-6500K	≥80	IP66	CREE

AL-68CT



AL-68CS



LED Illustro

Product Features:

- Aurald Illustro Bollard is a new concept full stainless steel 316 Bollard with root mount SS fixing. The concept means the connection inside the base allows for the head to be removed without any connection due to the Induction coupling technology.
- Marine Grade SS316 Bollard
- SS root mount Kit

Dimension(mm):

