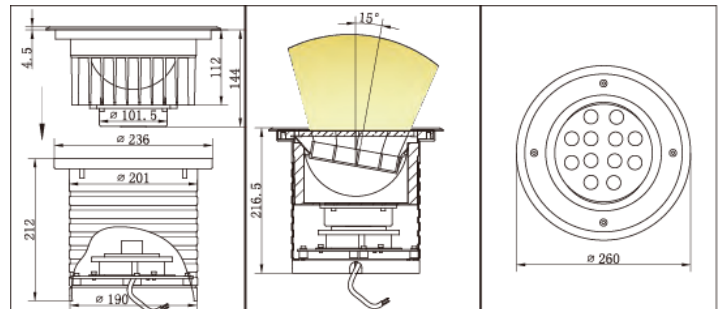
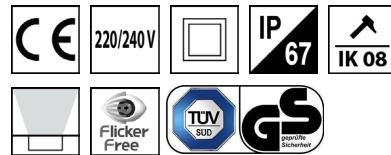

Recessed LED Inground Lamp

INDUCTION COUPLING

SS316

GENERAL SPECIFICATION

Product Family	AL-ILL260-AY-18W
Voltage supply	AC220-240V 50/60Hz 24VDC
Operating temperature range Ta	-15/+50 ° C
Maintenance & cleaning	H2O; Antistatic tissu
Sources of light	COB
Brand of sources	CREE
Mac Adam range	+/- 150K (Mac adam 3)
Life time L80B10 at 25° C	50000hrs
Life time L70B50 at Ta Max	35000hrs
Brand of Driver	AC PCB-B
Cycles on/off	>25000
Ripple current	- Flicker free
Position driver on fixture	Induction - integrated
Body material	Aluminum/Stainless steel 316L
Diffuser material	Tempered Glass
Reflector material	-
Closing clips material	-
Fixation	Spring fixation
Electrical network interface	Cable 1.5m H05RNF 2G 16A
Surge protection	
Vandal proof	-
Throught wiring	-
Accessories	-
Remarks	-

LIFE TIME AND WARRANTY

Nominal life time	50000hrs
Warranty	5 years

NORMS & DIRECTIVES

Nominal norms marking	CE /TUV/GS
CE directive	CEI 60598-1 CEI 60598-2-2 : 2012
Security Photobiological	CEI 62471 - : 2008 : RG0
Inflammable surface compliancy	F
Other marking	ASTM B117

OPTIONS

Dimming	NONE
CCT color temperature	3000K [3]; 5000k [5]; 6000K [6]; Blue [B]; Green [G]; Red [G]
CRI color rendering index	-
Coulor of product	-
Reflector/Optic	-
Mounting accessories	Earth pole [LX002]; concrete basket [LX001]
Other option	-

Installation instructions

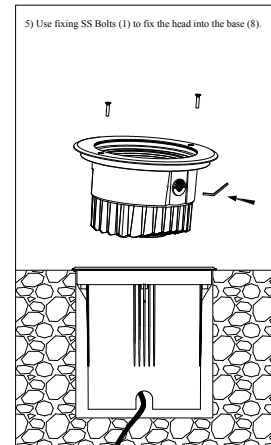
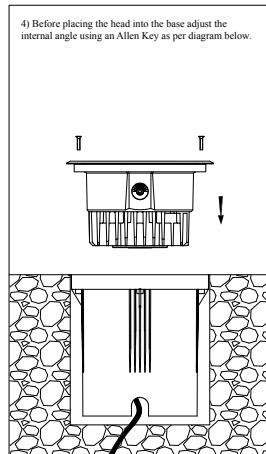
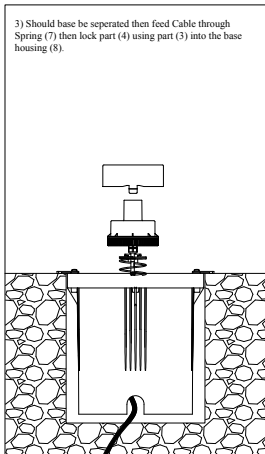
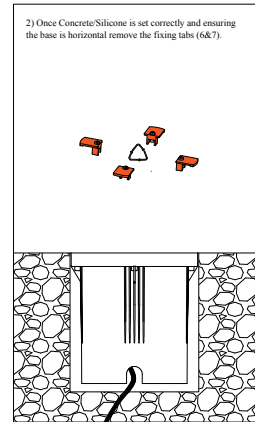
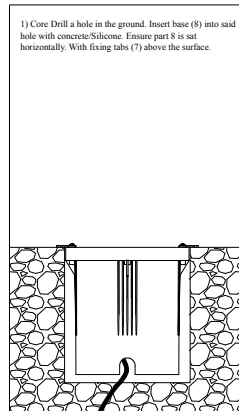
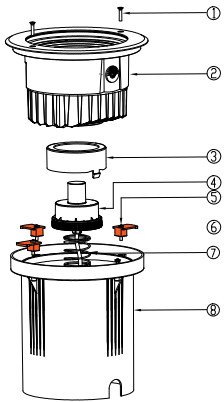

Follow installation instructions carefully. Ensure all below ground termination is totally sealed. Do not shorten the cable lengths provided on the fixture. Ensure all power is Off during installation until circuit is complete.

IP68 Connector:

AL-68CT

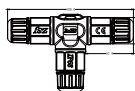

AL-68CS

